



## AutoNav: Bluetooth Controlled Robot Car

---

Sadman Salim Nipun and Richard Victor Biswas

EasyChair preprints are intended for rapid dissemination of research results and are integrated with the rest of EasyChair.

May 31, 2023

# AutoNav: Bluetooth Controlled Robot Car

**Abstract--** A Bluetooth controlled robot car is a type of robotic vehicle that can be operated using a Bluetooth-enabled device such as a smartphone or a tablet. The car is equipped with a Bluetooth module that communicates with the device, allowing the user to control the car's movements and actions wirelessly. The robot car typically consists of a chassis, two DC motors with wheels, a motor driver module, an Arduino or another microcontroller, an HC-05 or HC-06 Bluetooth module, a breadboard and jumper wires, and a power source. A controller app sends commands to the robot car in a specified format, which the microcontroller interprets and translates into motor movements. The car also features a color sensor which can detect specific color. A Bluetooth controlled robot car can be used for various applications such as entertainment, education, and research. It provides a fun and interactive way to learn about robotics and programming while also allowing for experimentation and customization of the car's behavior.

**Index Terms—**Arduino based project, Bluetooth, motor control, vehicle control, color sensor, controller app, smartphone, microcontroller, motor driver, robotics.

## I. INTRODUCTION

The design of a robot car that can be operated over Bluetooth is an intriguing area of research since it draws from several subdisciplines in engineering and computer science. Robotics, motor control, wireless networking, and programming are all fundamentals that must be mastered. To make learning about robotics and programming more engaging, we're building a robot car that can be controlled over Bluetooth. With this tech, we can build a portable platform that can be operated from a distance by any Bluetooth-enabled gadget, such as a phone or tablet. The potential uses in fields like entertainment, education, and science are enormous as a result. A Bluetooth-operated robot car is a useful educational tool for teaching kids about robotics and computer programming. Motor control theory, wireless networking, and popular programming languages like C++ and Python are all available to students. They can also experiment with various sensor and actuator setups to see how those changes affect the vehicle's behavior.

The usage of a robot car that is controlled by Bluetooth allows researchers to test out novel ideas and technologies in the fields of robotics and wireless networking. Robots that can navigate, recognize objects, or monitor their surroundings can be developed through experimentation with various control algorithms and sensor setups. In conclusion, the design of a robot car that can be operated by Bluetooth is an interesting and promising field of study with numerous potentials uses in the fields of education, entertainment, and scientific research.

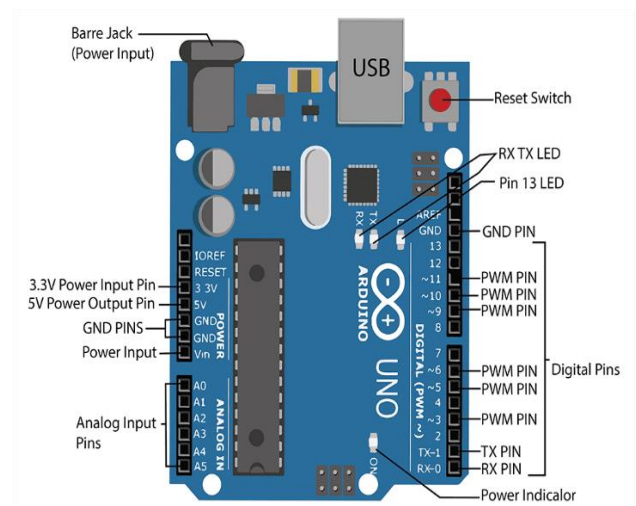

Fig. 1. Diagram of Arduino Uno.

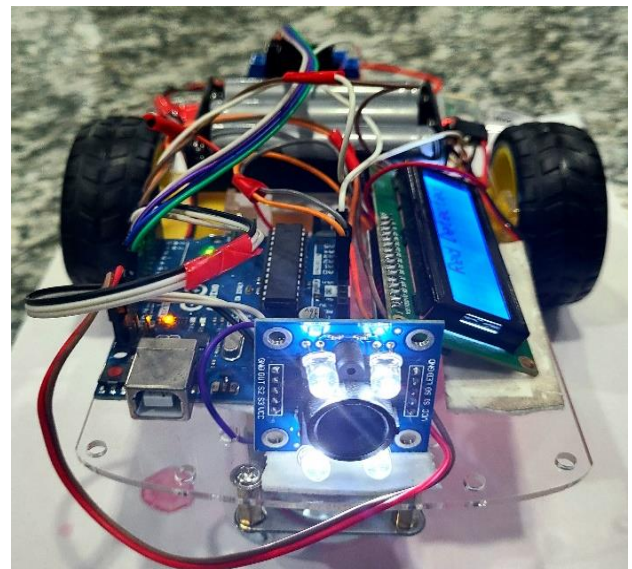

Fig.2. Robot Car.

The objectives are to design and construct a functional robot car that is capable of movement and steering under the control of Motor Controller module, to program an Arduino Uno microcontroller board to interpret incoming signals from a Bluetooth Module as commands for the car's motors to move forward, backward, turn left, or turn right, to establish a wireless Bluetooth connection between a mobile application and the Bluetooth module that allows the user to control the car's movement via a graphical user interface (GUI) on their smartphone, to integrate an I2C LCD Display to provide real-time color detection of objects in front of the car.

A Bluetooth controlled remote car is a type of robotic vehicle that can be remotely controlled using a Bluetooth-enabled device such as a smartphone or tablet. The car is equipped with a Bluetooth module that communicates with the device, allowing the user to control the car's movements and actions wirelessly. Our Bluetooth controlled car AutoNav consists of a chassis, two DC motors with wheels, a motor driver module, an Arduino or another microcontroller, an HC-05 or HC-06 Bluetooth module, a breadboard and jumper wires, and a power source. The motors are connected to the motor driver module, which is then connected to the microcontroller. The Bluetooth module is also connected to the microcontroller, which receives commands from the Bluetooth-enabled device and translates them into motor movements for the robot car.

AutoNav also has a color sensor to detect specific color. A color sensor is a type of sensor that can detect and differentiate between different colors. In a robot car, a color sensor can be used to detect the color of objects in the car's surroundings and respond accordingly. Color sensors work by measuring the intensity of light reflected off an object and analyzing the different wavelengths of light to determine its color. The sensor emits light onto the object and then measures the amount of light that is reflected back. Based on the wavelengths of light reflected, the sensor can determine the color of the object.

The Bluetooth controlled remote car can be used for various applications, such as entertainment, education, and research. It provides a fun and interactive way to learn about robotics and programming while also allowing for experimentation and customization of the car's behavior.

## II. LITERATURE REVIEW

The development of Bluetooth controlled cars has become an emerging trend in the field of robotics due to the convenience of controlling the car from a distance using a mobile application. Many researchers have explored the application of Bluetooth technology in robotics and developed different types of Bluetooth controlled cars. In a study by S. Ali et al. (2018) [1], an Android based Bluetooth controlled car was developed using Arduino microcontroller and L293D motor driver. The car was controlled by an Android app which communicated with the Arduino microcontroller via Bluetooth.

The results showed that the car was able to move in different directions and perform tasks according to the commands received from the mobile app.

Another study by D. Chen et al. (2017) [2] developed a Bluetooth controlled car using Arduino and HC-05 Bluetooth module. The car was equipped with an ultrasonic sensor to avoid obstacles and a line following sensor for path detection. The results portrayed that the car was able to move and navigate autonomously. A study by S. Ahmed et al. (2021) [3] developed a Bluetooth

controlled car using Arduino, L298N motor driver, and an Android app. The car was equipped with an obstacle avoidance system using a distance sensor. The results also conveyed that the car was able to avoid obstacles and move in different directions based on the commands received from the mobile app. In a study by T. Wang et al. (2019) [4], a Bluetooth controlled car was developed using Arduino and a Bluetooth module.

Another study by Y. Lin et al. (2020) [5] developed a Bluetooth controlled car using an ESP32 microcontroller and a Bluetooth module. The car was equipped with a color sensor and was able to detect and follow a colored path. It also presented that the car was able to follow the path with high accuracy. However, the results demonstrated that the car was able to avoid obstacles and move in different directions based on the commands received from the mobile app.

## III. METHODOLOGY AND MODELING

Our Bluetooth controlled robot car is a type of robot vehicle that can be remotely controlled using a Bluetooth-enabled device such as a smartphone or tablet with unique features and capabilities. The following is the list of the components-

### Components:

1. A robot car chassis.
2. L298N Dual Motor Controller Module.
3. 3.7V 18650 Rechargeable Li-ion Battery.
4. Arduino Uno.
5. HC-05 Bluetooth Module Breakout.
6. TCS3200 Color Sensor Module.
7. I2C LCD Display (16x2).
8. Universal Charger for Li-ion Battery.
9. Wires and others.

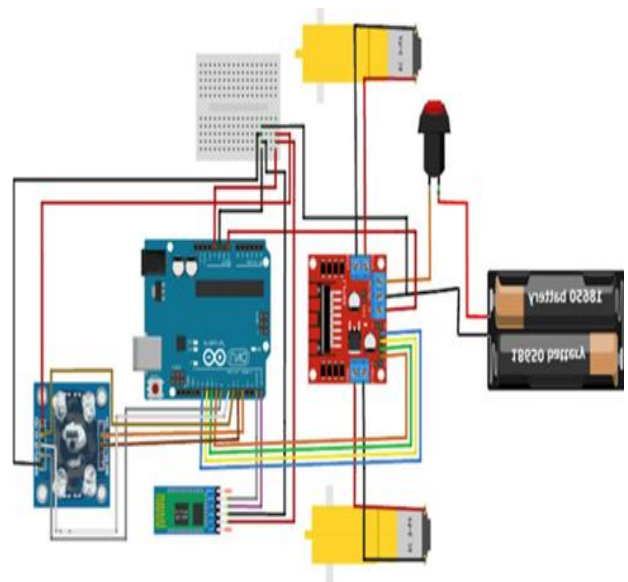
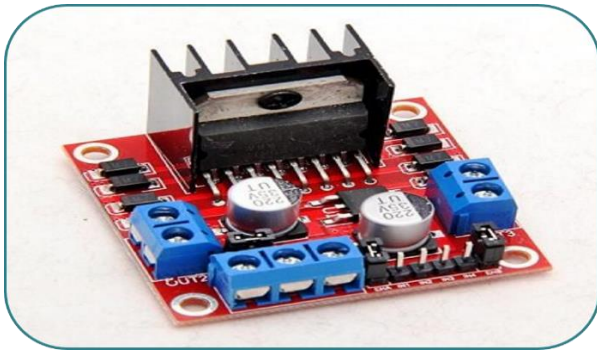
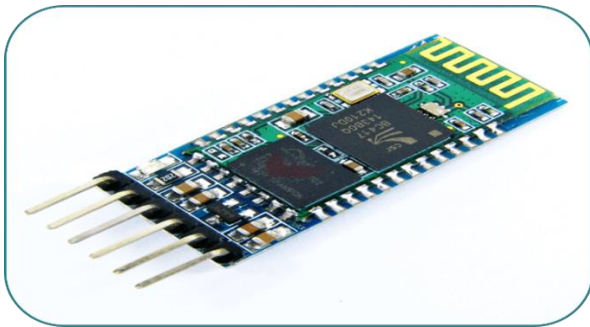

Fig.3. Simulation Diagram.



**Fig.4.** Driver module.



**Fig.5.** HC-05 module.



**Fig.6.** TCS3200 chip.

We have first assembled the chassis using components, wires and necessary components and mount the motors on the chassis. Then we have connected the motor driver module to the microcontroller and the motors. After that, we have connected the Bluetooth module to the microcontroller, ensuring that the pins are connected correctly.

Next, we have written the code for the microcontroller to control the motor movements and interpret the signals from the Bluetooth module. Then, we have tested the robot car's movements by sending commands from a Bluetooth enabled device. By then, we have added color sensor to detect and respond to different colors in the robot car's surroundings. I2C LCD display is implemented with the module to show the detected color.

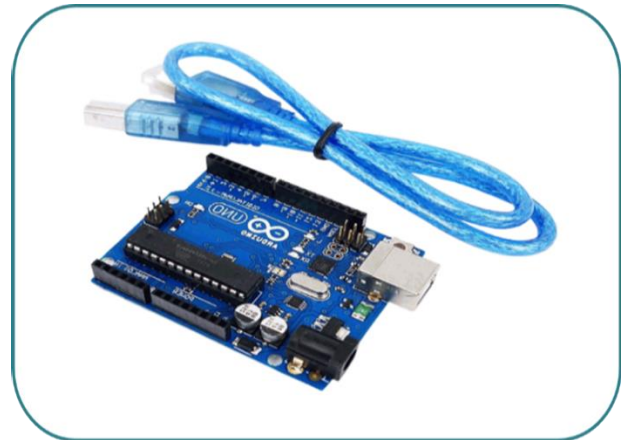

**Fig.7.** Arduino.

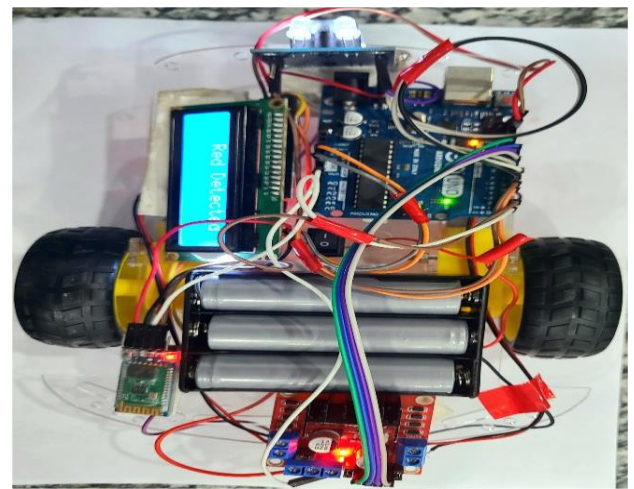

**Fig.8.** AutoNav Robot Car.

#### IV. RESULTS

After finishing the draft circuit, the simulation was also done using the TinkerCad software.

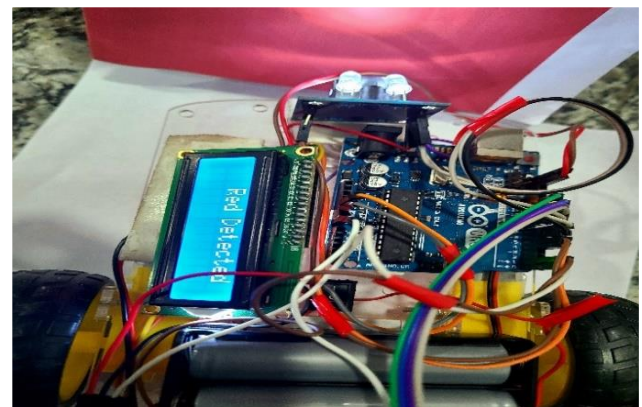

**Fig.9.** Red Color Detected.

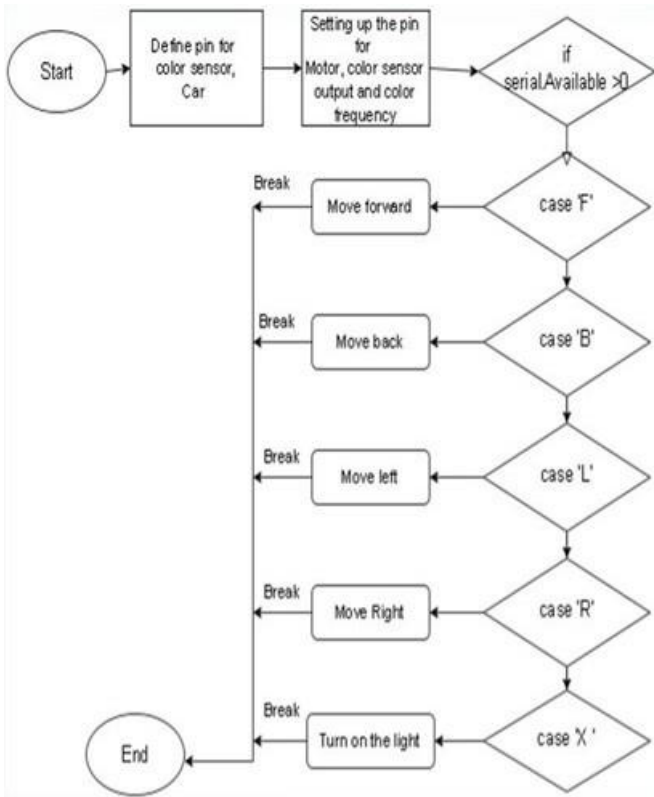

**Fig.10.** Working flowchart of the robot car.

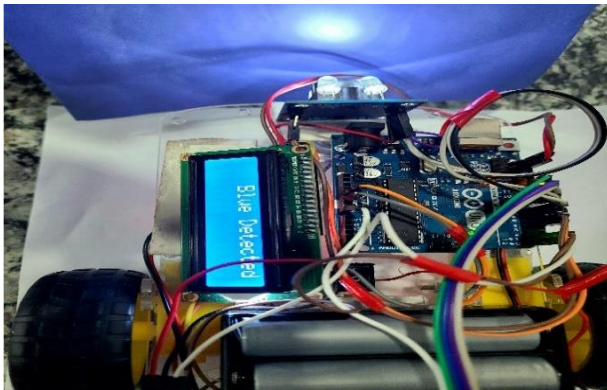
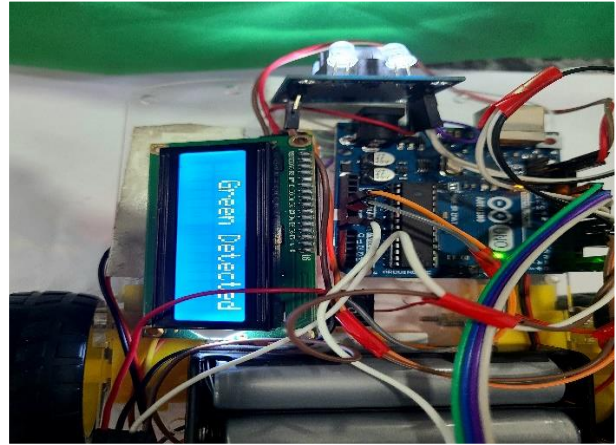

**Fig.11.** Blue Color Detected.

By comparing the numerical and experimental results, we have determined the accuracy and validity of the simulation model. The simulation model accurately predicts the behavior of the robot car in the real world which is why the numerical and experimental results are almost similar. If there we found any significant differences between this two, then it might indicate that the simulation model needs to be refined or adjusted. AutoNav has provided valuable insights into the performance and the behavior of the Bluetooth controlled robot car having a color sensor.

By using these tools and techniques, we have optimized the design and control of the robot car to achieve the desired performance and behavior. After detecting the color, the LCD display has showed the following

message. After testing the system, it has been observed that the system is able to detect color by color sensor and show output on the display provided.



**Fig.12.** Green Color Detected.

After testing the system, a few limitations are observed. Bluetooth technology has a limited range, typically up to 10 meters. This means that the robot car must stay within this range of the device controlling it. Bluetooth signals can be disrupted by other devices using the same frequency band. This can cause signal interference and affect the robot car's performance.

Bluetooth signals can experience a delay, especially if there are obstacles between the device and the robot car. This delay can affect the car's response time and make it less responsive to the control signals. Robot cars rely on batteries to power their motors and electronics. However,

Besides, the color sensor used in Arduino can detect a limited range of colors. It can only detect colors within the visible spectrum of light, which means it cannot detect infrared or ultraviolet light. The color sensor's accuracy can be affected by factors such as lighting conditions, surface reflectivity, and angle of incidence. The readings can be affected by ambient light, which can cause incorrect color readings. The resolution of the color sensor used in Arduino is relatively low, which can limit its ability to differentiate between similar colors. Moreover, the detection range of the color sensor can be affected by factors such as surface reflectivity and lighting conditions.

## V. DISCUSSIONS

AutoNav is a simple yet effective robotic system that combines the capabilities of Bluetooth wireless communication with a color sensing system. This system can be used in a variety of applications, such as industrial automation, home automation, and educational robotics. The color sensor enables the robot car to detect and differentiate between different colors, allowing it to follow color-coded paths or identify specific objects based on their color.

This capability is useful in applications such as warehouse automation, where the robot car can be programmed to follow a color-coded path to navigate through the warehouse and pick up or deliver items. The Bluetooth wireless communication technology allows the robot car to be controlled remotely from a smartphone, tablet, or computer. This enables the operator to control the robot car from a safe distance and monitor its performance in real-time.

Additionally, Bluetooth connectivity can be used to transmit data between the robot car and other devices, allowing the robot car to be integrated into a larger network of connected devices.

However, there are limitations to the Bluetooth controlled robot car having a color sensor, as discussed earlier. These limitations include the limited range of Bluetooth technology, signal delay, limited bandwidth, and limited color detection range and accuracy of the color sensor. Overall, a Bluetooth controlled robot car with a color sensor is a simple nevertheless versatile robotic system that can be used in a variety of applications. Its capabilities can be further enhanced by integrating other sensors and technologies, such as GPS, LiDAR, and machine vision, to enable more advanced functionalities such as autonomous navigation and object recognition.

## VI. CONCLUSION

In conclusion, our AutoNav is a versatile and useful robotic system that combines Bluetooth wireless communication with color sensing capabilities. This system can be used in a variety of applications, including industrial automation, home automation, and educational robotics. The color sensor allows the robot car to detect and differentiate between different colors, enabling it to follow color-coded paths or identify specific objects based on their color. The Bluetooth wireless communication technology allows the robot car to be controlled remotely from a smartphone, tablet, or computer, enabling real-time monitoring and control of the system.

While the system has some limitations, such as the limited range of Bluetooth technology and the limited color detection range and accuracy of the color sensor, these can be overcome by integrating other sensors and technologies to enable more advanced functionalities. The future endeavors of the Bluetooth controlled robot car having a color sensor are vast and promising. The system is relatively low cost and can be easily customized and upgraded, making it accessible to a wide range of users. To sum up, AutoNav is a simple moreover worthwhile system that can be used to automate a variety of tasks, reduce human labor, and increase efficiency in a range of applications. With the ability to integrate additional sensors and technologies, this system has the potential to be a game-changer in a range of industries and applications.

Here are a few potential areas for further development

and exploration:

1. Autonomous navigation: The integration of GPS, LiDAR, and machine vision technology could enable the robot car to navigate autonomously, making it a more efficient and effective solution for industrial and logistic applications.
2. Object recognition: The color sensor could be integrated with machine vision technology to enable the robot car to recognize and classify objects based on their color and shape, enhancing its functionality in a range of applications.
3. Enhanced communication: The robot car's Bluetooth communication could be enhanced with the integration of Wi-Fi or 5G technology, allowing for faster and more reliable data transfer.
4. Energy efficiency: The robot car's power management system could be optimized for energy efficiency, potentially enabling it to operate for longer periods without requiring recharging or replacement of batteries.
5. Artificial Intelligence (AI) integration: The integration of AI could enable the robot car to learn and adapt to new environments and tasks.

## REFERENCES

- [1] S. Ali, A. Naeem, M. A. Arshad, and F. Khan, "Design and development of android-based Bluetooth controlled car," in 2018 5th International Conference on Control, Decision and Information Technologies (CoDIT), 2018, pp. 185-190.
- [2] D. Chen, M. Yang, and W. Jiang, "Design and Implementation of an Intelligent Bluetooth Remote Control Car Based on Arduino," in 2017 IEEE International Conference on Mechatronics and Automation (ICMA), 2017, pp. 197-201.
- [3] S. Ahmed, M. A. Hassan, A. Omer, and M. A. Shaikh, "Development of Bluetooth Controlled Car with Obstacle Avoidance," in 2021 2nd International Conference on Smart Systems, Innovations and Computing (SSIC), 2021, pp. 340-345.
- [4] T. Wang, Q. Zhang, X. Liu, and Y. Liu, "Design and implementation of intelligent Bluetooth car based on Arduino," in 2019 IEEE 6th International Conference on Industrial Engineering and Applications (ICIEA), 2019, pp. 182-186.
- [5] Y. Lin, S. Wang, and S. Lu, "Design of the ESP32 Bluetooth Controlled Intelligent Car Based on Smart Mobile Terminal," in 2020 IEEE 3rd International Conference on Electronic Information and Communication Technology (ICEICT), 2020, pp. 173-177.