



## IOT Based Hand Gesture Recognition System

---

G Joel Richard, S S Shurvesh and J Sree Sankar

EasyChair preprints are intended for rapid dissemination of research results and are integrated with the rest of EasyChair.

March 13, 2023

# IOT Based Hand Gesture Recognition System

Joel Richard. G<sup>1</sup>, Shurvesh. S.S<sup>2</sup>, Sree Sankar. J<sup>3</sup>

<sup>1,2</sup> UG Scholar, Department of CSE, Karunya Institute of Technology and Sciences, Tamilnadu

<sup>3</sup> Assistant Professor, Department of CSE, Karunya Institute of Technology and Sciences, Tamilnadu

**Abstract:** To control the spreading of corona virus there is a need to advance the exchanging innovation for supplanting contactless switch. This project deals with a design that has a no-touch model that works entirely on card gestures. This smart contactless switch includes a sensor that can detect card movements and translates them into commands for controlling lights, fans, and various home appliances. The main idea is to build a feasible device for contactless switching, this will eliminate the touching of a switch so people can use it very easily. Another social cause for coming up with this project is to avoid the risk of COVID19, it is significant not to contact surfaces including switches that have been frequently used by other people, especially in hospitals. In order to replace a hand-operated switch with an automated contactless switch, new switching technology is required.

*Keywords* —Monitoring System, Pandemic Real-life Usage, Ultrasonic sensor, automation

## I. INTRODUCTION

Switches need to be updated to reflect modern needs as technology continues to evolve. It has become crucial to avoid touching buttons and keys whose surfaces have previously been extensively used by others in order to reduce the chance of catching COVID-19. As a result, switching technology must be improved to allow for the automatic contactless switch's replacement of the hand-operated switch. Therefore, it is necessary to create a no-touch switch that relies solely on hand gestures. Our intelligent contactless switch has a sensor that can identify hand movements and transform them into instructions for lighting, fans, and other household appliances, particularly in hospitals. To stop the current corona virus epidemic and mass transmission, it is crucial to build a contactless surface. Switches that have been used regularly by others, particularly in hospitals, are examples of highly contractive surfaces. As a result, switching technology must be improved to allow for the automatic contactless switch's replacement of the hand-operated switch.

The main objectives of the proposed system include 1) To reduce the possibility of COVID-19 and the widespread spread of viruses among individuals, 2) To help those with disabilities, 3) Switching technology innovation when approaching the switch, 4) Be careful to prevent electric shocks. Switching technology automation, 5) the main idea is to build a workable device for contactless switching, which will eliminate the touching of a switch so people can use it very easily, 6) Easy access to smart switches by the people, 7) The goal is to keep up with the current electrical appliance advancements in the era of automation and fully connected industrial internet of things (IIoT).

This paper is organised in the following structure such as Section-1 Literature Survey, Section-2 Proposed design, Section-3 Experimental Results, Section-4 Future Scope.

## II. RELATED WORKS

In 2012 [1] Khan et al. proposed and conducted a survey of recent hand gesture recognition systems is presented. Challenges of the gesture system are addressed together with key difficulties of the hand gesture recognition system. Additionally, review

techniques for current posture and gesture detection systems are described. A summary of the hand gesture study findings is also provided, along with a comparison of the key stages of gesture recognition. Finally, advantages and disadvantages of the systems under discussion are presented. In 2013 [2] Yang et al. proposed a hand gesture recognition has been applied to many fields in recent years, especially in man-machine interaction (MMI) area, which is regarded as a more natural and flexible input. This paper provides a current summary of hand gesture recognition research, including the typical steps of hand gesture recognition,

In 2015 [3] N. Mohamed et al. reviewed the sign language research in the vision-based hand gesture recognition system from 2014 to 2020. Its goal is to determine what has improved and what needs more attention. Using chosen keywords, we were able to extract 98 articles from well-known web resources. The study demonstrates that the area of vision-based hand gesture recognition research is busy, with several studies being undertaken and dozens of publications being published yearly in journals and conference proceedings therefore. In 2017 [4] Nandwana et al. proposed a Hand gesture recognition used in many applications like HCI, robotics, sign language, digit, and alphanumeric value. In this survey research, we briefly outline the fundamental technique for hand gesture detection and discover that, in contrast to vision-based technologies and glove-based techniques, the Kinect sensor is often employed.

In 2017 [5] S. Hussain et al. found new possibilities to interact with machine and to design more natural and more intuitive interactions with computing machines, The goal of the study is computer vision-based automated gesture interpretation. In the present study, we provide a method for controlling a computer by means of six static and eight dynamic hand gestures. In 2017 [6] H. Sun et al. With the improvement of computer vision, the demand for interaction between human and machine is becoming more and more extensive. The segmentation of hand gestures is achieved in the article by developing a skin colour model and an AdaBoost classifier based on hair to account for the

specificities of skin colour for hand motions. Additionally, hand movements are denaturalized with one frame of video being clipped for analysis.

In 2018 [7] Yassen M et al. proposed that, With the development of today's technology, and as Humans frequently communicate with hand gestures as a natural method to clarify their intentions, recognition of hand gestures is an important part of Human Computer Interaction (HCI), It enables computers to record and decode hand gestures, understand them, and then carry out orders. In 2019 [8] Ruben Nogales et a. proposed their research consists in the information conveyed via hand motions and thus complement oral communication or by themselves provide a means of interhuman communication. In this article, we give a thorough assessment of the literature on machine learning and infrared data-based hand gesture detection.

In 2020 [9] Akshatha et al. have studied the various method of gesture recognition. A more natural and effective human computer interface tool is thought to be the hand gesture recognition system. We spoke about the End-Point algorithm and a couple of its Mono-vision approaches in this essay. Each of them made each move with their hands. In 2020 [10] Yassen M et al. have discussed the gesture acquisition methods, the hand motion categorization procedure, feature extraction, the applications that were recently proposed, the difficulties that researchers are facing in the hand gesture detection process, as well as its potential.

In 2022 [11] Kaur et al. proposed a useful application in touchless human-machine communication in real-world problems. This review paper offers a thorough analysis of current deep learning-based systems. The papers were chosen using a methodical process. In 2023 [12] Saleem et al. described in this publication offers a platform for communication so that the D-M and the ND-M may interact without having to learn sign language. The system uses a COTS LMD device to collect hand motion data, which is subsequently analyzed using CNN. It is dependable, simple to use, and based on these features. In addition to CNN, supervised

machine learning algorithms are used to analyses and automatically recognize sign language.

In 2023 [13] Mownika Reddy K A et al. proposed One way to communicate information through the movement of body is through gestures. The current state of hand gesture recognition research is reviewed in this paper, along with the typical steps of hand gesture recognition,

### III. PROPOSED DESIGN

The block diagram the proposed hand gesture system is shown in Fig 3.1

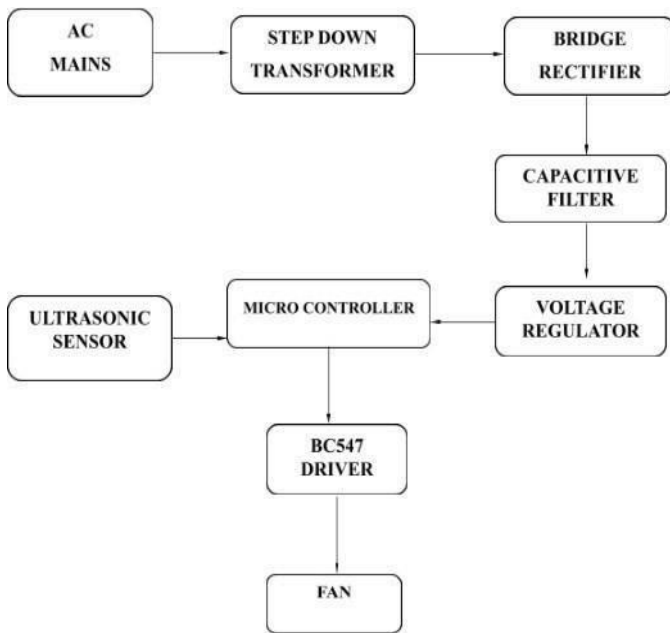

Fig 3.1 Proposed Design

The hardware components for the proposed design include ultrasonic sensor, PIC16F877A Microcontroller, Global System for Mobile (GSM), LCD Display, Power supply unit, Bluetooth Module and RF module.

**Ultrasonic Sensor:** A device that uses sound waves to detect a distance to an object is called an ultrasonic sensor. By emitting a sound wave at a certain frequency and listening for the return of that sound wave, it calculates distance. The distance between the sonar sensor and the item may be determined by keeping track of how long passes between the sound wave's generation and its return.

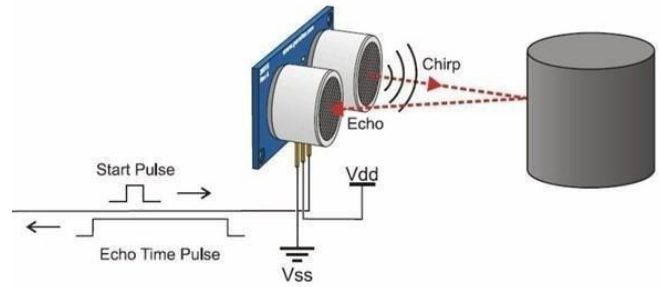

Fig.3.2. Working of ultrasonic sensor

**PIC16F877A Microcontroller:** One of Microchip's most sophisticated microcontrollers is the PIC 16F877. Because of its low cost, variety of uses, good quality, and simplicity of availability, this controller is frequently utilized for experimental and contemporary applications. It is perfect for uses like machine control, measuring devices, research, and other related things. The PIC 16F877 is equipped with all the parts that contemporary microcontrollers typically have.

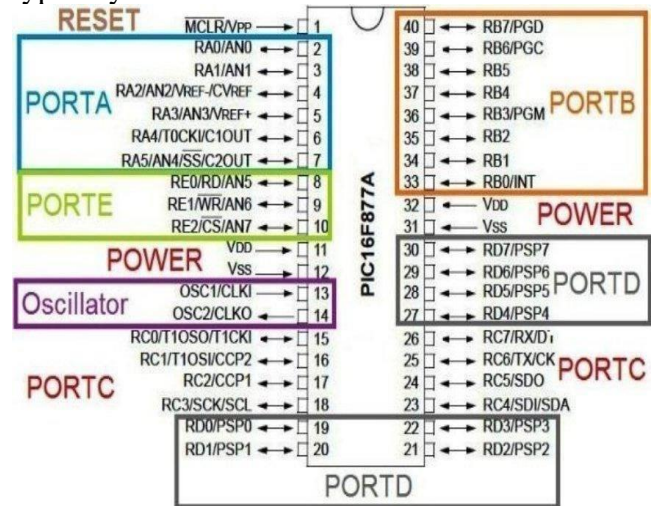

Fig 3.3 Pin details of PIC16F877A microcontroller

<b>PORT-A</b>	RA-0 to RA-5	6 bit wide
<b>PORT-B</b>	RB-0 to RB-7	8 bit wide
<b>PORT-C</b>	RC-0 to RC-7	8 bit wide
<b>PORT-D</b>	RD-0 to RD-7	8 bit wide
<b>PORT-E</b>	RE-0 to RE-2	3 bit wide

Fig 3.4 Ports details of Microcontroller

**Global System for Mobile (GSM):** With the aid of this digital cellular technology, mobile voice and data services are sent. The data transfer rate is between 64 kbps to 120 Mbps. A computer connected to a base station serves as the foundation for the launch of a GSM-SMS remote control system for greenhouses. A base station is composed of a microcontroller, GSM module, and sensors. Through a GSM module, the central station receives and transmits messages.



Fig 3.5 GSM Module

**LCD Display 16\*2:** The 16x2 Arduino LCD screen makes use of the I2C communication interface. With a blue background and white characters, it can display 162 characters over two lines. The LCD 1602 Parallel LCD Display's drawback of requiring around 8 Arduino pins to operate is overcome with this display.



Fig 3.6 Liquid Crystal Display (LCD)

**Power Supply Unit:** An electrical circuit known as a power supply is created to deliver a constant dc voltage of a certain value across load terminals, regardless of ac mains fluctuations or load changes. A straightforward power supply and a voltage regulator are the two fundamental components of a regulated power supply. The voltage regulating

component receives the power source output as input and produces the final output. Despite significant fluctuations in the input AC voltage or the output load, the power supply's voltage output stays constant current.

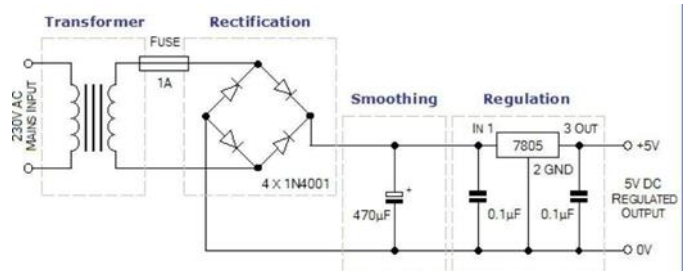

Fig 3.7 Power Supply Unit

**Bluetooth Module:** An intuitive Bluetooth SPP (Serial Port Protocol) module called the HC-05 is made for setting up transparent wireless serial connections. A fully certified Bluetooth V2.0+EDR (Enhanced Data Rate) 3Mbps modulator with a full 2.4GHz radio transceiver and baseband is available as a serial port Bluetooth module. It utilizes the CMOS and AFH-enabled CSR Blue core 04-External single chip Bluetooth system (Adaptive Frequency Hopping Feature). Its footprint is just 12.7 mm by 27 mm.

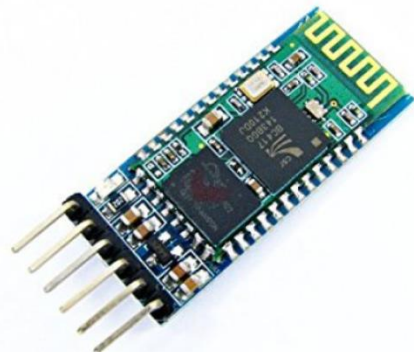

Fig 3.8 Bluetooth Module

**RF module:** Bluetooth and ZigBee RF modules are the most popular ones. Bluetooth is utilized for close-proximity communication (approximately 10 meters). For long-distance communication, utilize Zigbee (approximately 100 meters). Zigbee provides a more convenient deployment scenario for full

hardware deployment. Since this is a prototype deployment, Bluetooth is sufficient in terms of cost and output, deployment, Bluetooth is sufficient in terms of cost and output.

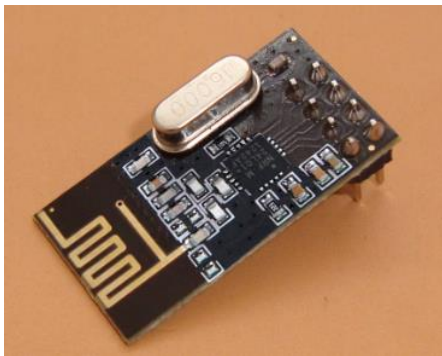

Fig 3.9 RF Module

Non-functional requirements refer to behavioral properties that the system must have, such as performance and usability.

**Performance requirements** which is the fundamental requirement for the model are, The system should respond immediately to any leakage situation, The system should update the local database in real time, The system should make a decision within 5 seconds, The Microcontroller response time should be fast, The ultrasonic sensor should be activated from anywhere at any time, The usability requirements required are, The system interface should be easy and effective (User-friendly) and the availability requirement is, The system should work 24 hours 7 days a week. The security requirements can be defined as, The communication between the Microcontroller and the GSM and RF module should be secure by encryption, The system should not lag in performance.

#### IV. EXPERIMENTAL RESULTS

The PIC16F630/676A microcontroller, which is powered by an AC supply, an ultrasonic sensor, and a power supply unit make up the suggested technique. The project model comprises of a gesture-detection device that recognizes hand gestures, interprets them as commands, and then uses a microcontroller to manage the load. Through a contactless hand gesture-controlled switch, an NPN

transistor fastens the Arduino control mode to lights and fans. In its stead, we have used a microcontroller since it is less expensive and easier to install than the Internet of Things.

**ORCAD:** OrCAD, a proprietary software tool package primarily used for electrical design automation, was created by OrCAD Systems Corporation (EDA). The programme is primarily used by electronic design engineers and electronic technicians to produce printed circuit boards by producing electronic schematics, mixed-signal simulation, and electronic prints. Using the Simulink to PSpice Interface, OrCAD EE may optionally interact with MATLAB/Simulink and execute simulations for circuits created in OrCAD Capture (SLPS). An integrated circuit simulation and verification solution with schematic entry, native analogy, mixed signal, and analysis engine is offered by OrCAD Capture and PSpice Design.

#### Implementation of the code:

```
#include <main.h>
#use rs232(baud=9600, xmit=PIN_C4, rcv=PIN_C5, ERRORS) //#use
rs232 ( baud=9600, xmit=pin_C4, rcv=pin_C5, parity=N, stop=1 ) int16
distance, time; // Defining variables
// Defining the pins

#define trig pin_C0
#define echo pin_A2
#byte porta = 0x05
#byte portc = 0x07
#byte trisa = 0x85
#byte trisc = 0x87
#bit BUZ = 0x07.1
int8 count=0; int8
i=0; unsigned int16
r; int8 DEVICE=0;
void check()
{
output_high(trig); // ping the sonar
delay_us(20); // sending 20us pulse
output_low(trig);
```



## Working Model:

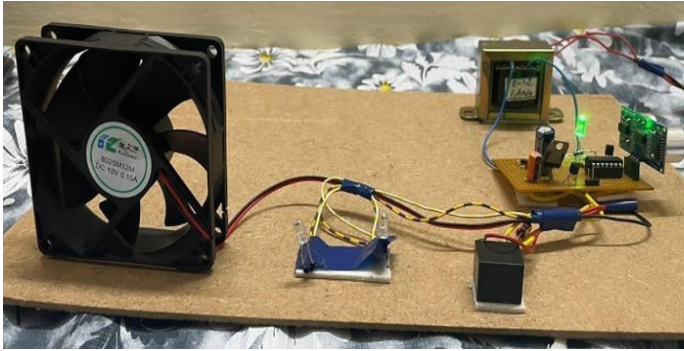

Fig 4.1 In Off State

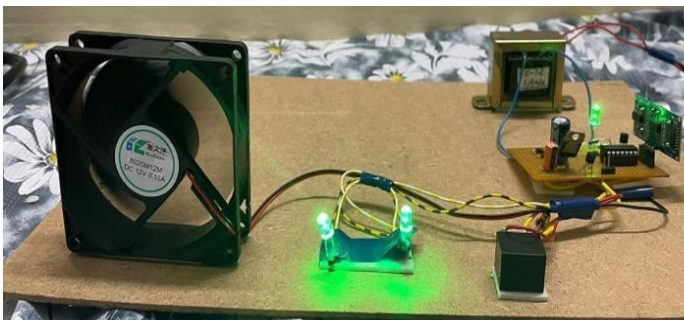

Fig 4.2 In ON State

## V. CONCLUSION

With the use of an ultrasonic sensor that is controlled by a micro-controller in this project, the accessing of switches directly in-contact has been abolished, paving the way for limiting the transmission of illnesses like the corona virus. A contactless electric switch uses a sudden change in internal resistance in a control element linked in series with the load to connect, disconnect, and transfer current in electrical circuits instead of physically closing or opening contacts. These components might be relay-moded magnetic amplifiers with feedback, semiconductors with resistances that change depending on the intensity of a control current, semiconductor resistances with parameters that change when heated, or other elements. Due to the total lack of any moving components, touchless switches have a very high dependability. They typically have no issues being used outside due to their enclosed design and good IP protection.

## VI. FUTURE SCOPE:

More datasets in sign language can be analyzed and contributed in the future. Based on the suggestions made by ML-based algorithms, the size of the dataset can potentially be enhanced. Videos and other sorts of data, such as word-level hand gestures, can be added to datasets to enhance them further. There is still more to be done in terms of comparing various sign languages, identifying their commonalities, and then integrating them to produce bigger databases. By including more training aspects, the suggested communication system may be further tailored for certain users.

## REFERENCES

- [1] Khan, Rafiqul Zaman & Ibraheem, Noor. (2012). Hand Gesture Recognition: A Literature Review. *International Journal of Artificial Intelligence & Applications (IJAIA)*. 3. 161-174. 10.5121/ijaia.2012.3412.
- [2] Yang, Shuai & Premaratne, Prashan & Vial, Peter. (2013). Hand gesture recognition: An overview. *Proceedings of 2013 5th IEEE International Conference on Broadband Network and Multimedia Technology, IEEE IC-BNMT 2013*. 63-69. 10.1109/ICBNMT.2013.6823916.
- [3] N. Mohamed, M. B. Mustafa and N. Jomhari, "A Review of the Hand Gesture Recognition System: Current Progress and Future Directions," in *IEEE Access*, vol. 9, pp. 157422-157436, 2021, doi: 10.1109/ACCESS.2021.3129650.
- [4] Nandwana, Bhumiika & Tazi, Satyanarayan & Trivedi, Sheifalee & Kumar, Dinesh & Vipparthi, Santosh. (2017). A survey paper on hand gesture recognition. 147-152. 10.1109/CSNT.2017.8418527.
- [5] S. Hussain, R. Saxena, X. Han, J. A. Khan and H. Shin, "Hand gesture recognition using deep learning," 2017 International SoC Design Conference (ISOCC), Seoul, Korea (South), 2017, pp. 48-49, doi: 10.1109/ISOCC.2017.8368821.

- [6] J. -H. Sun, T. -T. Ji, S. -B. Zhang, J. -K. Yang and G. -R. Ji, "Research on the Hand Gesture Recognition Based on Deep Learning," 2018 12th International Symposium on Antennas, Propagation and EM Theory (ISAPE), Hangzhou, China, 2018, pp. 1-4, doi: 10.1109/ISAPE.2018.8634348.
- [7] Yasen M, Jusoh S. 2019. A systematic review on hand gesture recognition techniques, challenges and applications. PeerJ Computer Science 5:e218 <https://doi.org/10.7717/peerj-cs.218>
- [8] Yasen M, Jusoh S. A systematic review on hand gesture recognition techniques, challenges and applications. PeerJ Comput Sci. 2019 Sep 16;5:e218. doi: 10.7717/peerj-cs.218. PMID: 33816871; PMCID: PMC7924500
- [9] G, Akshatha. "Literature Survey on Hand Gesture Recognition System." International Journal for Research in Applied Science and Engineering Technology 8, no. 2 (2020)
- [10] Kaur, Arpneek and Sandhya Bansal. "Deep Learning for Dynamic Hand Gesture Recognition: Applications, Challenges and Future Scope." 2022 5th International Conference on Multimedia, Signal Processing and Communication Technologies (IMPACT) (2022): 1-6.
- [11] Saleem, Muhammad Imran, Atif Siddiqui, Shaheena Noor, Miguel-Angel Luque-Nieto, and Enrique Nava-Baro. 2023. "A Machine Learning Based Full Duplex System Supporting Multiple Sign Languages for the Deaf and Mute" Applied Sciences 13, no. 5: 3114. <https://doi.org/10.3390/app1305311>
- [12](2023). A Review on Dynamic Hand Gesture Recognition Techniques. International Journal for Research in Applied Science and Engineering Technology. 11. 1340-1347. 10.22214/ijraset.2023.49256.
- [13](2023). A Review on Dynamic Hand Gesture Recognition Techniques. International Journal for Research in Applied Science and Engineering Technology. 11. 1340-1347. 10.22214/ijraset.2023.49256.