



Monitoring Lumbar Pain Using Smart Lumbar Belt

I Jeya Daisy, B Vinoth Kumar and M Krishnamoorthi

EasyChair preprints are intended for rapid dissemination of research results and are integrated with the rest of EasyChair.

March 5, 2023

Monitoring lumbar pain using Smart Lumbar Belt

I. ABSTRACT

As per World Health Organization (WHO) states that 500,000 to 800,000 humans are struggling with the pain due to seating in the same posture for many hours for their daily work. In this pandemic circumstance, the younger generation is getting impacted and the number of cases rises, also leading to spinal cord difficulties substantially the lower back discomfort. The spinal cord is the longest bone and is surrounded by rings of bone in the human body used to detect the lower back pain we choose the lumbar (L1 to L5) and pelvic (S1 to S4) regions in the vertebrae. In the middle of the bones, intervertebral discs are found and provide more flexibility in movement. The common type of pain is caused because of bad posture, long sitting hours and lack of exercise. The lower back pain occurred due to the muscles being more focused on this project.

Keywords— lumbar pain, bad posture, emg sensor

II. INTRODUCTION

Approximately 80% of the population is experiencing lower back pain. To minimize the count, we are developing a smart lumbar belt. The belt identifies discomfort in people who are in an unnatural position and have been in that position for a long time and sends a message to the user as an alert to get rid of the extreme pain in the lumbar area. Because of the improper position and strain on the back, the pain occurs and causes fever, swelling in the back, and kidney difficulties. To avoid some serious complications, we use a lumbar belt to detect it early. The objective of the project is to detect the spinal cord position and early-stage pain in the lumbar and pelvic region. To detect lower back pain which causes in the lumbar and sacral muscles, we use Electromyography (EMG) signals. [1] A flex sensor is used for detecting the angle of the person in the sitting posture and this is one of the ways to detect spinal cord early-stage pain using different structures. [2] To sense the lower back pain using muscle movements of the humans in the lumbar region, we found electromyography (EMG) signals. [3] The information of the movements is conveyed to muscles and carries signals through lower motor neurons. [4] The flex sensor is fixed in the spinal cord of the person especially in lumbar region. [5] The EMG sensor with electrodes is placed in the tight quadratus lumborum region (T12 to L4). All the sensors are interfaced with the microcontroller and output of the device as a message. [6] If this “smart lumbar belt” comes into the existence there would be a positive response in the healthcare.

III. LITERATURE SURVEY

This is the survey we conducted to learn what people's opinions were before to beginning our project. For our survey, 120 persons in total replied. Most respondents said they were experiencing lumbar pain as a result of sitting in one place for an extended period of time, and a small number of elderly respondents said they were experiencing pain as a result of getting older.

Are you Employee or Senior Citizen

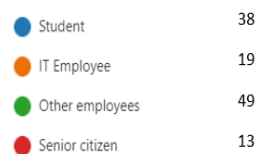

Why does the pain occurs

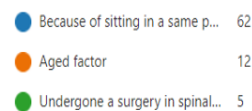

These are the papers we looked over for a variety of concepts and modern trends, and we created a better version using them as a guide.

[1] Finding the lumbar position

The lumbar position is identified using a mini gyroscope and accelerometer. The capacitive resistive sensor is used and located over spinal cord externally which gives audio beep when abnormal bending movement. All the devices are connected to Arduino (UNO). Scoliosis patients can utilize this device. To avoid spinal deformities and preserve proper posture.

[2] Wearable sensor determining the electronic skin

Bodily movements are determined using E-skin. The ability of E-skin sensors used to measure lumbar and pelvic anatomical angles. E-skin and Vi Move sensors both are used to detect the movements of lumbar region in spinal cord. By doing many experiments, they concluded that E-skin sensor has more comfortable and costs low.

[3] Lower back disorders

Before two years majorly working persons affected by lower back pain. Frequent bending and twisting are some of the risk factors. Twisting is defined as trunk rotation, whereas bending is defined as trunk flexion in a forward or lateral motion. Posture is the arrangement of our body's many components. Awkward posture occurs when the muscles, tendons, and ligaments are overworked. The people are divided into two generations and carried out three different sitting postures. They concluded 90–120-degree results of stress level.

IV. COMPONENTS NEEDED

[1] FLEX SENSOR - The particles give the ink away with little resistance when the sensor is upright. When the sensor is rotated away from the ink, the conductive particles migrate and increase the resistance. Two wires serve as the sensor's outputs, and when it bends, the output varies correspondingly. Flex sensor testing is possible with or without an op-amp and a voltage divider. When the metal pads are outside of the bend, the flex sensor's resistance changes.

[2] EMG SENSOR -EMG sensor used to detect the weaker muscles while pain occurs. EMG measure even no action in muscle. Calcium ions are released within the muscle, causing a mechanical shift in muscular tension. The reference electrode should be placed in the muscle's inactive part, while the other two electrodes should be placed throughout its length of the lumbar muscle.

[3] ADC MODULE (MCP3008) - As an 8-Channel 10-bit ADC, the MCP3008 can measure 8 distinct analogue voltages with a 10-bit resolution. It measures analog voltage values between 0 and 1023 and transmits those values via SPI communication to a microcontroller or microprocessor. It can run on 3.3V. It is the most affordable and user-friendly. It converts analog voltage to a digital number using the SAR method.

[4] RASPBERRY PI 3B+ MODULE – Hereby we have used Raspberry Pi 3B+ module as a microcontroller. It runs on a dual-core ARM11 processor with 512MB of SDRAM

and receives its power from a Micro USB 5V connector. A data receive from a raspberry pi is stored on sever. A website is used to register and preserve the specific information of patients and doctors. The system design explains how different components are interconnected. The sensors are attached to the patient's body.

V. PROPOSED METHODOLOGY

A. BLOCK DIAGRAM

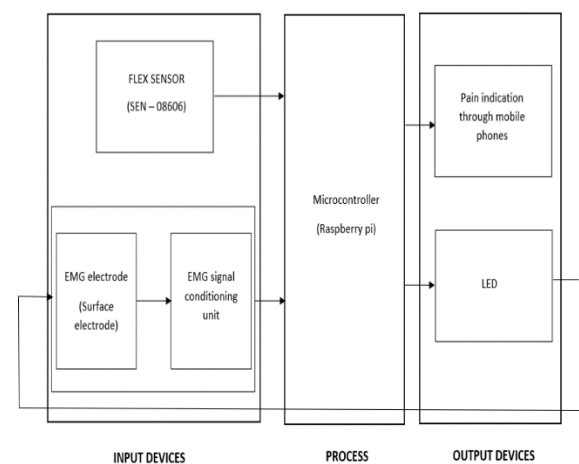

In the input stage, the flex sensor determines a constant bending angle. Therefore, a person can bend only up to normal lumbar angle range. The angle is between 35 and 40. The muscle strength is monitored using Electromyography (EMG) sensor with disposal electrodes. Because when the muscle gets irritated and disks are bulged, the voltage increases and frequency decreases from the EMG sensor which indicates weaker signal. In the second stage, when the angle is more than 40 degree it is directly connected with the EMG sensor output. The timer starts counting the hours and sacral muscle also gets weaker when a person sits more than certain time approximately one hour in same position. When the timer reaches one hour with same angle the EMG sensor output will get activated. In third stage, when the timer reaches one hour with same angle the LED blinks. If the voltage from the EMG sensor which indicates weaker signal are detected then SMS will

be spent through mobile phone to change the sitting position. The message is as “A warning is to change your position”.

These are the real time data generated from flex sensor using various subjects. The subjects were made to sit in different postures to attain the desired output. At a flat angle (straight position) we get the resistance as 9.8k ohm.

B.REAL TIME DATA

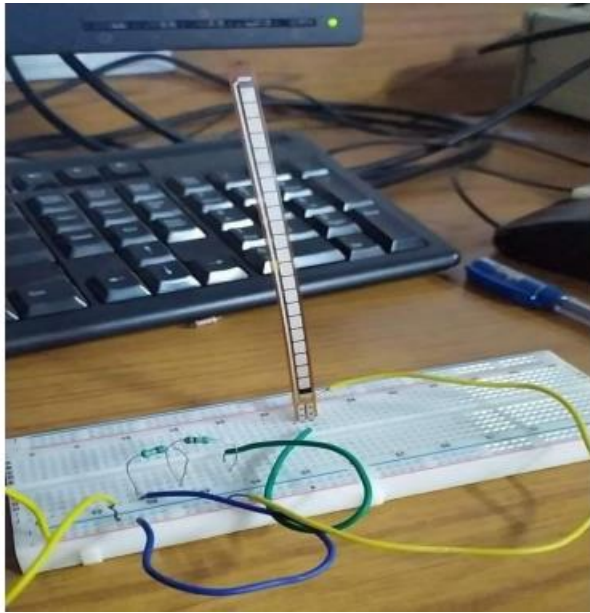

Here the values are, $R_1 = 20k \text{ ohm}$, $R_L = \text{flex sensor}$,
 $V_{in} = 5V$.



Here the subject were made to sit at the 45-degree angle we obtain 13.4k ohm.



The subject was instructed to sit in 60-degree angle we get 14.4k ohm,



And finally, In the angle 90 the subjects will be heading a 17.4k ohm.

C. FLOW CHART

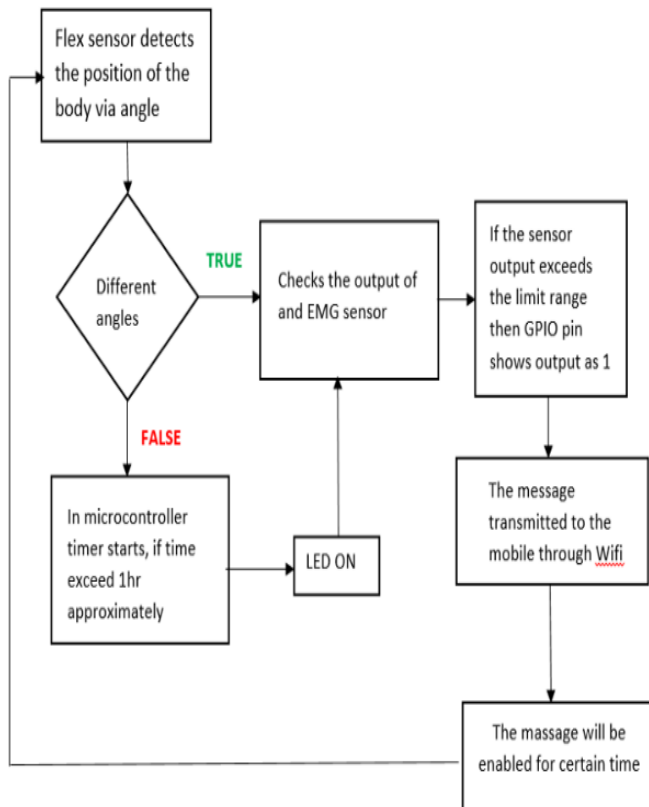

VI. HARDWARE IMPELEMENTATION

A. BELT DESIGN

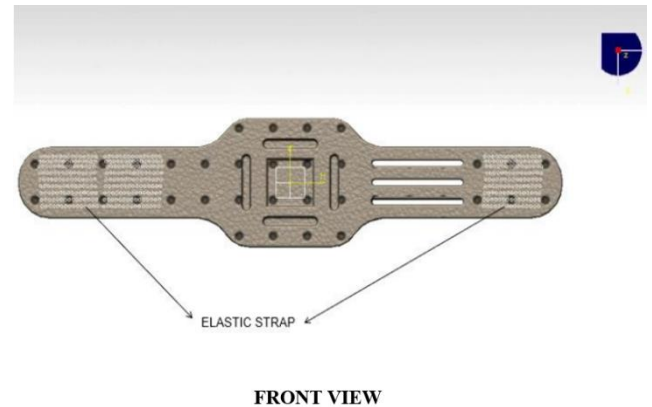

The smart lumbar belt design is executed in solid works, measuring 170 cm in length and 60 cm in width. The central portion is 60 cm wide and 60 cm long.

B. CIRCUIT OF FLEX SENSOR

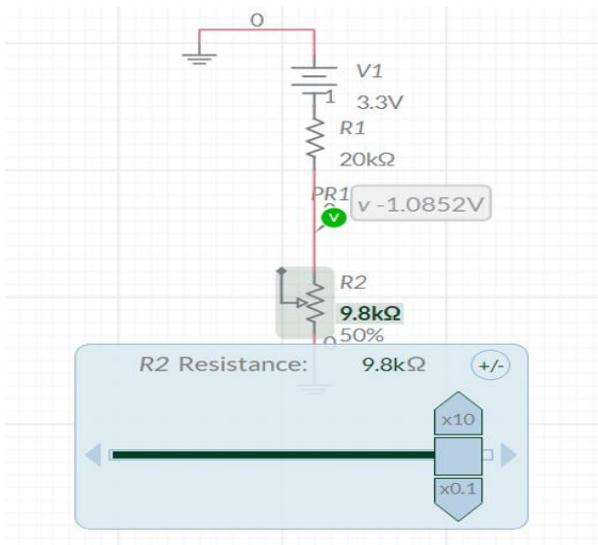

D.FINAL CIRCUIT

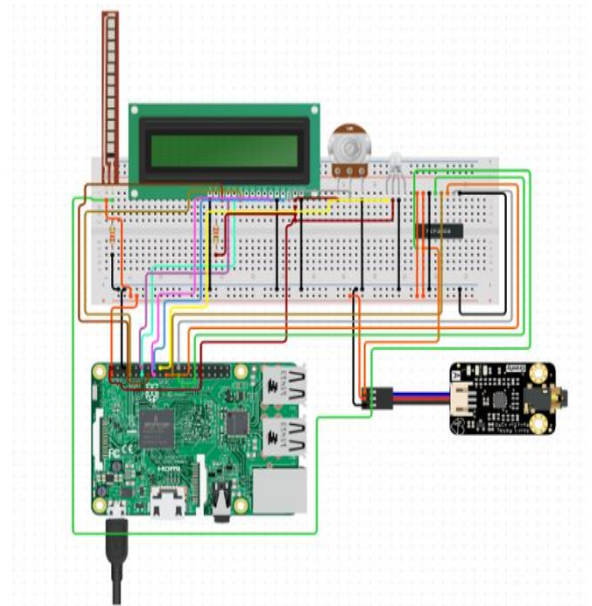

C. CIRCUIT OF EMG SENSOR

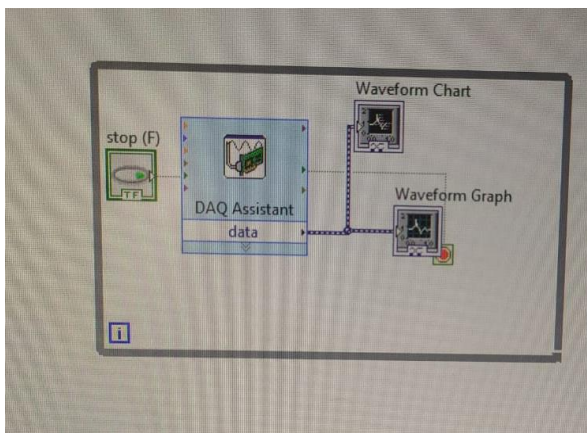
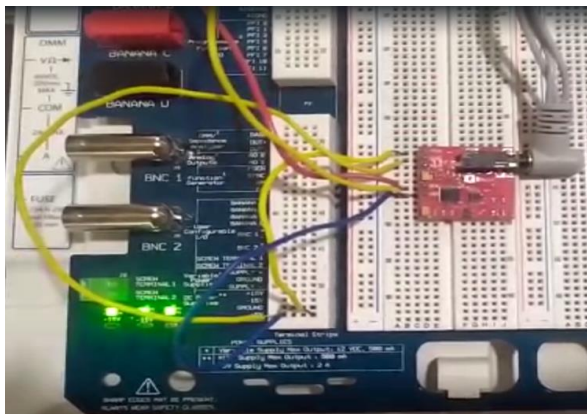

E. PROTOTYPE

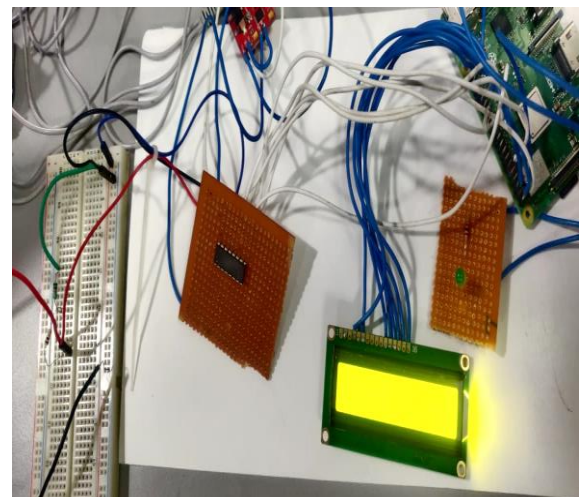

VII.RESULTS OF SENSORS

A. RESULTS OF FLEX SENSOR

The results acquired from the formula,

$$V_{out} = (RL/R1+RL) * V_{in}$$

Angle	RL (Flex sensor)	Output voltage(vout)
0	9.8k ohm	1.64V
30	10.3k ohm	1.7V
45	13.4k ohm	2V
60	14.3k ohm	2.1V
90	17.4k ohm	2.32V

Time - sec	Amplitude - Voltage (back)
0	0.770689
0.001	0.770689
0.002	0.771334
0.003	0.771334
0.004	0.771011
0.005	0.771011
0.006	0.771011
0.007	0.771011
0.008	0.770689
0.009	0.770689
0.01	0.771011
0.011	0.771011
0.012	0.771011
0.013	0.771011
0.014	0.770689
0.015	0.770367
0.016	0.771011
0.017	0.770689
0.018	0.771011
0.019	0.770689
0.02	0.771334
0.021	0.770689
0.022	0.771011
0.023	0.771334
0.024	0.771011
0.025	0.771656
0.026	0.770045
0.027	0.771656
0.028	0.771011

0.029	0.771011
0.03	0.771334
0.031	0.770689
0.032	0.771011
0.033	0.770689
0.034	0.771011
0.035	0.771334
0.036	0.770689
0.037	0.771011
0.038	0.771656
0.039	0.771011
0.04	0.770689
0.041	0.771011
0.042	0.771656
0.043	0.771656
0.044	0.771334
0.045	0.771011
0.046	0.770367
0.047	0.771011
0.048	0.771334
0.049	0.771011

B.RESULTS OF EMG SENSOR

Time - sec	Amplitude - Voltage
0	0.771011
0.001	0.770689
0.002	0.770689
0.003	0.771011
0.004	0.770689
0.005	0.770367
0.006	0.770367
0.007	0.771011
0.008	0.771656
0.009	0.771011
0.01	0.771011
0.011	0.771011
0.012	0.770689
0.013	0.771011
0.014	0.770689
0.015	0.771011
0.016	0.771334
0.017	0.771334
0.018	0.771011
0.019	0.770689
0.02	0.771011
0.021	0.771011
0.022	0.771011
0.023	0.771011
0.024	0.771334
0.025	0.770689
0.026	0.771011
0.027	0.770689
0.028	0.771334

0.029	0.770689
0.03	0.771334
0.031	0.771011
0.032	0.770689
0.033	0.771011
0.034	0.771334
0.035	0.771011
0.036	0.770689
0.037	0.771334
0.038	0.770367
0.039	0.770689
0.04	0.771656
0.041	0.771011
0.042	0.771011
0.043	0.770689
0.044	0.771011
0.045	0.770689
0.046	0.771334
0.047	0.771011
0.048	0.771011
0.049	0.771011

Time - sec	Amplitude - Voltage (front)
0	0.770689
0.001	0.771011
0.002	0.770689
0.003	0.771656
0.004	0.771334
0.005	0.770689
0.006	0.770367
0.007	0.771656
0.008	0.771334
0.009	0.771334
0.01	0.770689
0.011	0.771334
0.012	0.770689
0.013	0.770689
0.014	0.770689
0.015	0.771011
0.016	0.771334
0.017	0.771334
0.018	0.771011
0.019	0.770689
0.02	0.771011
0.021	0.771334
0.022	0.771334
0.023	0.770689
0.024	0.771011
0.025	0.771656
0.026	0.771011
0.027	0.771656
0.028	0.771334

0.029	0.771011
0.03	0.771011
0.031	0.771011
0.032	0.771334
0.033	0.771011
0.034	0.770689
0.035	0.771011
0.036	0.770689
0.037	0.771011
0.038	0.771011
0.039	0.771334
0.04	0.771011
0.041	0.770689
0.042	0.771011
0.043	0.771334
0.044	0.771334
0.045	0.771011
0.046	0.771011
0.047	0.770689
0.048	0.771011
0.049	0.771011

EMG sensor output

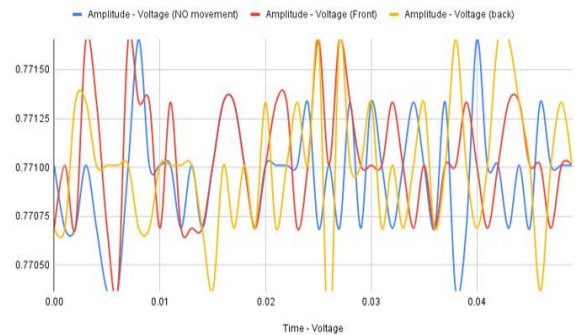

Waveform of the EMG output

C. RESULTS OF UBIDOTS

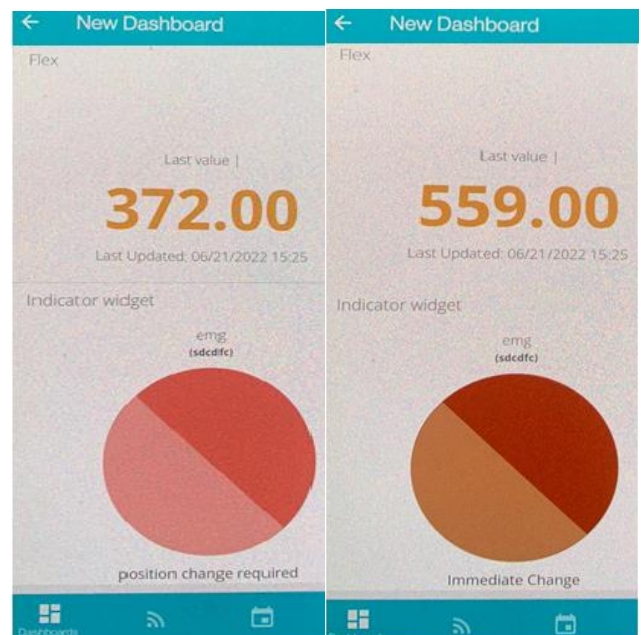

VIII.CONCLUSION

A flex sensor and an EMG sensor, which determine the angle and pain in the muscle respectively, have been infused. Then, we make the decision to select the Raspberry Pi microcontroller because it has all the features necessary for our project. We are initiating people with an alert message as a result.

V.REFERENCES

1. M.Dhanalakshmi, J.Raja Paul Perinpam, Jose Anand, "Smart Indication System for spinal cord stress detection," International Journal of Recent Technology and Engineering (IJRTE), vol.8, issue 3, pp.6164-6168, Sep 2019.
2. Yuxin Zhang , Pari Delir Haghghi, Frada Burstein, Lim Wei Yap, Wenlong Cheng, Lina Yao and Flavia, "Electronic skin wearable sensors for detecting Lumbar Pelvic movements", p.p.1-28, Mar 2020.
3. <https://www.researchgate.net/publication/319116022> _Review_on_risk_factors_related_to_lower_back_disorders_at_workplaceBryn Farnsworth, "Electromyography and How does it works",IMOTION, July 2018
4. N. Nazmi, M. A. A. Rahman, S. A. Mazlan, H. Zamzuri and M. Mizukawa, "Electromyography (EMG) based signal analysis for physiological device application in lower limb rehabilitation," 2nd International Conference on Biomedical Engineering (ICoBE), pp.1-6, Mar 2015.
5. <https://www.researchgate.net/publication/312964018> _Quantitative_analysis_of_lumbar_muscles_performance_of_patients_with_lumbar_disc_herniation_based_on_surface_electromyography
6. <https://www.researchgate.net/publication/351129591> _Mapping_Responses_of_Lumbar_Paravertebral_Muscles_to_Single-Pulse_Cortical_TMS_Using_High-Density_Surface_Electromyography
7. <https://ieeexplore.ieee.org/stamp/stamp.jsp?arnumber=8502033>
8. <https://www.researchgate.net/publication/344985754> _WEARABLE_POSTURE_IDENTIFICATION_SYSTEM_FOR_GOOD_SITTING_POSITION
9. <https://pubmed.ncbi.nlm.nih.gov/34011979>
10. Yee Mon Aung,Adel AI-Jumaily, "Estimation of upper limb joint angle using surface EMG signal", Sage journals, vol.10, issue.10, 2013.
11. Richard A, Ekstrom, Roy W Osborn, Patrick L Hauer, "Surface electromyographic analysis of the low back muscles during rehabilitation exercises", Journal of orthopaedic & sports physical therapy, vol.38, no.12, Dec 2008.
12. <https://www.researchgate.net/publication/315915463> _Wearable_posture_detection_and_alert_system
13. https://www.mdpi.com/journal/sensors/special_issues/emg?view=default&listby=date
14. <https://www.ijert.org/emg-signal-analysis-for-different-sitting-postures-with-and-without-backrest>
15. <https://www.researchgate.net/publication/270659087> _Using_surface_electromyography_SEMG_to_classify_low_back_pain_based_on_lifting_capacity_evaluation_with_principal_component_analysis_neural_network_method
16. <https://www.hindawi.com/journals/abb/2021/881748/>
17. <https://www.researchgate.net/publication/352714397> _ARE_YOU_SITTING_CORRECTLY_WHAT_RESEARCH_SAYS_A_REVIEW_PAPER_1