



EPiC Series in Computing

Volume 58, 2019, Pages 428–437

Proceedings of 34th International Conference on Computers and Their Applications



Effect of Magnet Shapes on Metal Contamination Removal

Takashi Ohnishi^{*1*2}, Takashi Okamoto^{*1*2}, and Keiichi Watanuki^{*1*3}

*1 Advanced Institute of Innovative Technology, Saitama University, Japan
255 Shimo-okubo, Sakura-ku, Saitama-shi, Saitama 338-8570 Japan

*2 Magnetec Japan Ltd.
5-521-1, Mikajima, Tokorozawa-shi, Saitama 359-1164 Japan
{ohnishi, okamoto}@magnetec.co.jp

*3 Graduate School of Science and Engineering, Saitama University
255 Shimo-okubo, Sakura-ku, Saitama-shi, Saitama 338-8570 Japan
watanuki@mech.saitama-u.ac.jp

Abstract

Foreign metal removal is a key process in the quality control of food and pharmaceutical industries. Previously, foreign metal removal involved the use of metal detectors. However, in recent years, magnet separators have been used to capture small metal particles and to improve the manufacturing yield when installed with previous metal detectors. Currently, most foreign metal material is austenitic stainless steel because product process equipment are manufactured using the same in order to make them corrosion proof. SUS304 and SUS316L are used commonly. Small metal particles adhere to the equipment by sliding and other processes thus contaminating the equipment. Austenitic stainless steels are not magnetized; however, weak magnetization is observed through martensite transformation during sliding and collisions. However, it is not easy to remove small stainless steel particles in production processes that involve powder flow. In this study, we investigated the removal rate of small stainless steel particles by three magnets of different shapes under the same conditions.

1 Introduction

Magnetic separators are used to remove foreign metal particles from powders, grains, and liquids. Magnetic separators can only remove magnetized material. Austenitic stainless steel is nonmagnetic; however, these particles can be removed by magnet separators after martensite transformation occurs. Austenitic stainless steels are commonly used for production equipment in order to make them corrosion proof. These are polished for sanitation purposes. Small metal particles can be

formed from materials that are already martensite transformed. Thus, it is possible to remove small austenitic stainless steel particles by a magnet under the right conditions.

Reference (1) presents an investigation on a specific magnetic separator, SUS304; however, it does not clarify how these results compare to other magnetic separators. This paper reports experimental results and clearly indicates the type of metal, size of particle, and the processing method used; the effect of magnet shapes on the removal rate were also evaluated. Reference (2) documents an investigation on the removal of iron particles by a plate magnet. However, bar magnets with a magnetic flux density over 1.0 T are commonly used, and in recent years, the more commonly removed material is austenitic stainless steel. Reference (3) documents for liquid filter employing a magnet for removal of iron particles. This paper has shown the magnets are effective to remove austenitic stainless steel particles.

We investigate three kinds of magnet shapes; circular, triangular, and pear-shaped magnets. Although circular and triangular magnets are commonly used, pear-shaped magnets have their advantages without the limitations.

Magnetic flux lines are generated evenly around circular magnets, as shown in Fig. 1(b). An advantage of circular magnets is that the captured metal particles move to the bottom with the flow of powder; the powder particles are not in contact with the captured metal particles, which stain the bottom of the magnet. A disadvantage of the circular magnet is that metal particles may not be attracted by the magnet if powder particles accumulate at the top of the magnet and block this attraction, as shown in Fig. 1(a).

Triangular magnets are shaped in such a way that an acute angle is formed at the top of the magnet; thus, the magnet is always visible and can attract metal particles continuously, because powder particles do not accumulate.

A disadvantage of the triangular magnet is that attracted metal particles do not move to the bottom and drop on the side owing to the shape of the magnet, as shown in Fig. 2(a).

Pear-shaped magnets are shaped in such a way that an acute angle is formed at the top and their bottom is rounded; thus, they can continuously attract metal particles, and these attracted metals are stained at the bottom, as shown in Fig. 3(a).

This study demonstrates the effect of magnet shape on metal removal by measuring the removal rate of weakly magnetized austenitic stainless steel using three kinds of magnets under the same conditions.

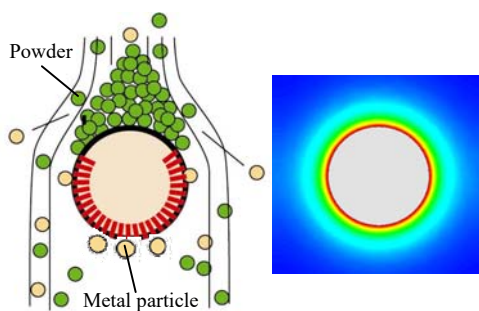

(a) Schematic of a magnet (b) Magnetic Flux line

Fig. 1 Features of a circular magnet

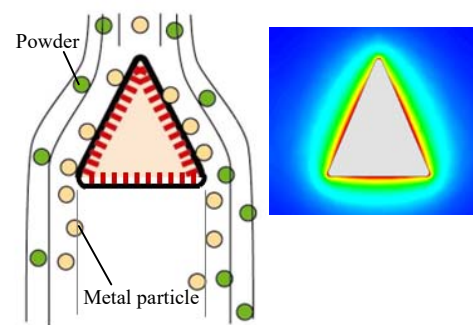

(a) Schematic of a magnet (b) Magnetic Flux line

Fig. 2 Features of a triangular magnet

2 Materials

2.1 Magnetic separator

Three configurations are set up with the same number of bar magnets, layers, and magnetic flux density, to ensure the same condition for each magnet shape, as shown in Figs. 4-6. The widths of the three magnets are shown in Fig. 7.

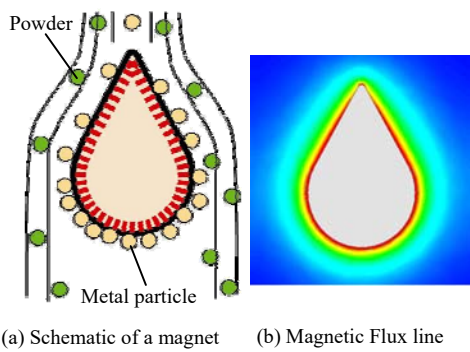
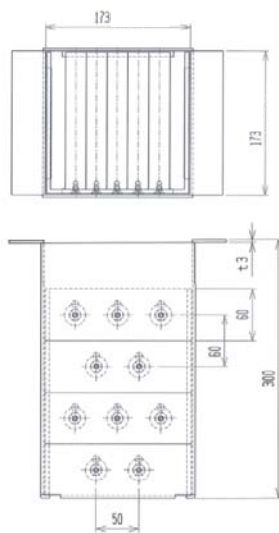
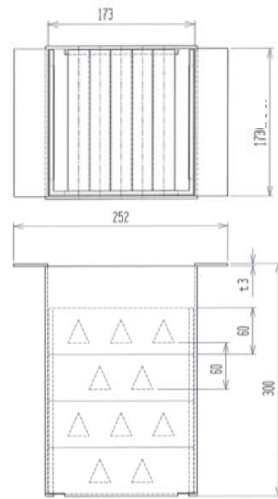

Fig. 3 Features of a pear-shaped magnet



Number of bar magnets: 10
Number of layers: 4
Magnetic flux density: 1.0 T

Fig. 4 Grate magnet with four layers of circular magnets



Number of bar magnets: 10
Number of layers: 4
Magnetic flux density: 1.0 T

Fig. 5 Grate magnet with four layers of triangular magnets

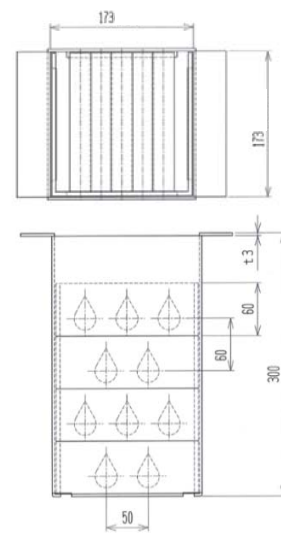

Number of bar magnets: 10
Number of layers: 4
Magnetic flux density: 1.0 T

Fig. 6 Grate magnet with four layers of pear-shaped magnets

2.2 Powder sample

We use medium-strength flour for this experiment, because it has a high accumulability as shown in Fig. 8 and Table 1, and can be easily differentiated.

2.3 Metal particles

Essentially, these three kinds of magnet are very effective in the removal of iron and martensite-transformed austenitic stainless steel particles and thus it is difficult to make compare their results. We prepared SUS304 particles with diameter of 0.1 mm, which is made by atomization method and 100 times of shot blasting to make weak martensite-transformed.

2.4 Experimental environment

From past experiments it can be seen that the flowability of powder is unstable with high humidity; thus, the removal rates are also unstable.

The experimental environment is set up in a small space with two dehumidifiers and a circulator. The humidity is maintained at 36-44% RH.

The experimental setup is shown in Fig.9 (a)-(d) and Fig. 10.

Ultrasonic sieve: Artec DGS35-100/200

Electromagnetic feeder: Sinfonia technology WCF-3

Electronic balance: A&D GH-12

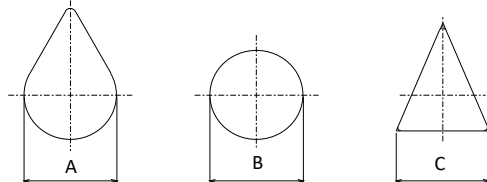

No.	Type	Width
A	Pear-shaped	25.2mm
B	Circular	25.2mm
C	Triangular	25.2mm

Fig. 7 Comparison for width of magnet



Fig. 8 Powder sample

Table 1 Powder specification

No.	Item	Value	Unit
1	Loose bulk density	0.44	g/cc
2	Tight bulk density	0.68	g/cc
3	Repose angle	88	degree
4	Collapse angle	72	degree
5	Spatula angle	95	degree
6	Spatula collapse angle	75	degree
	Temperature/humidity	15.8 °C/46%RH	

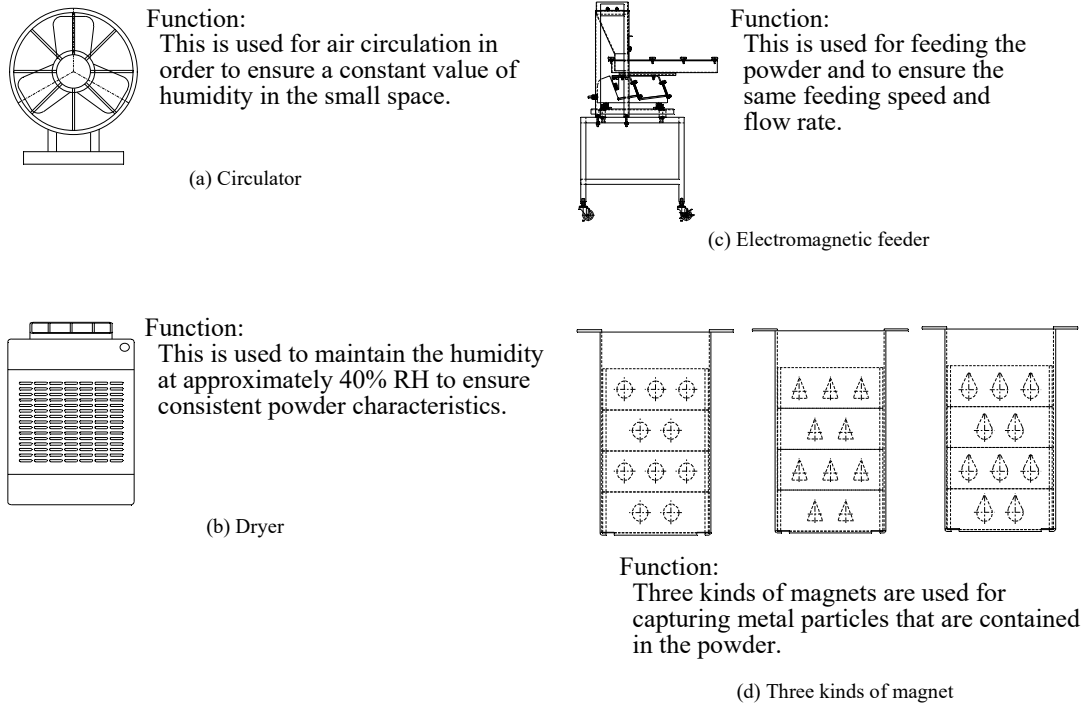

Fig. 9 Devices for the experiment

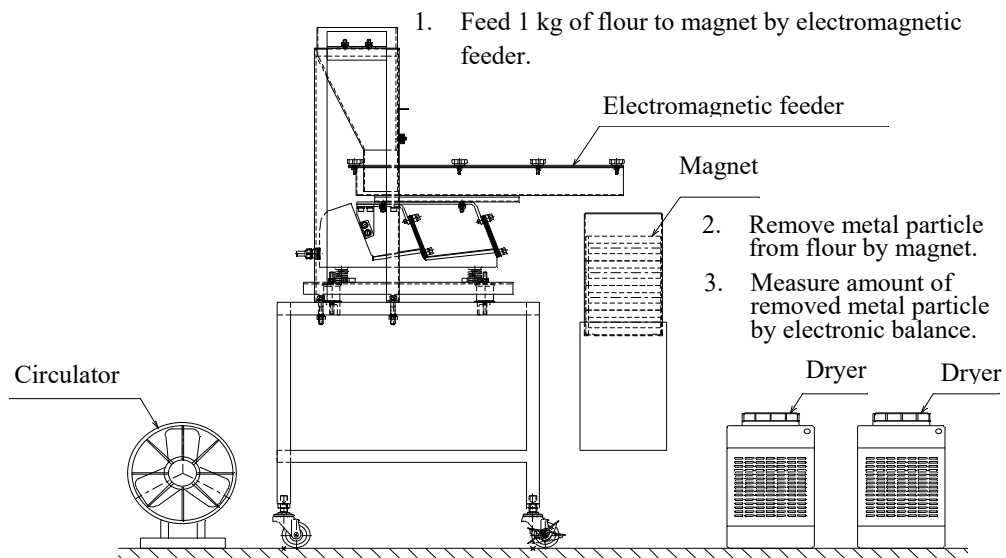

Fig. 10 Experimental environment

3 Methods

3.1 Experimental method

The experimental steps are as follows.

Pass 1 kg of flour through an ultrasonic sieve with an aperture size of 1 mm to break the lumps of flour and maintain consistency. Add 1 g of metal particles and mix evenly (approximately 100 times).

Feed the flour and metal mixture through the electromagnetic feeder and allow it to flow through to the circular, triangular, and pear-shaped magnetic separators for 43-50 seconds.

Measure the amount of metal particles removed by each layer of magnets by electronic balance.

We arranged the drop position of flour according to the magnetic pole that generates the magnetic field to ensure consistency in conditions and a valid comparison because each magnet has a different magnetic pole position.

Ultrasonic sieve: Artec DGS35-100/200

Electromagnetic feeder: Sinfonia technology WCF-3

Electronic balance: A&D GH-120

3.2 Evaluation method

The SUS304 particles that were separated by the circular, triangular, and pear-shaped magnets of each layer were collected. The removed metal particles are measured by an electronic balance, and then the removal rate is calculated from the amount of SUS304 particles removed, as shown in Table 1.

4 Results and Discussion

The results of SUS304 removal from flour by the circular, triangular, and pear-shaped magnets are shown in Table 2. The results show that the performance of the magnets in term of the removal rate follows the order: pear-shaped, circular, and triangular in Run 1 through Run 6. However, the order for Run 7 through Run 9 is pear-shaped, triangular, and circular. Little research has been conducted to show that the humidity of powders affects their accumulability. This may be the reason that the triangular magnets can remove a greater amount of metal than circular type as powder accumulated at the top of the magnet increases as the powders humidity changes.

As shown in Figs. 11-13, there is an increase powder accumulation on the top of magnet during the third test.

The results show that the pear-shaped magnet is the most effective in the removal of austenitic stainless steel.

Table 2 Results of comparison experiment for three kinds of magnet

Run	Type of magnet	Size of SUS 304	Amount of SUS304(g)	Removed amount for Magnet layer(g)				Total(g)	Temperature /humidity	Drop position	Flow time
				1st	2nd	3rd	4th				
1	Pear-shaped	Diameter 0.1 mm	1.0465	0.194	0.1682	0.1091	0.0403	0.5116	22.0°C	116mm	48.36sec
			100.0%	18.5%	16.1%	10.4%	3.9%	48.9%	37%RH		
2	Triangular		1.0494	0.0587	0.1335	0.1286	0.0415	0.3623	22.4°C	120mm	46.98sec
			100.0%	5.6%	12.7%	12.3%	4.0%	34.5%	36%RH		
3	Circular		1.0462	0.1241	0.1352	0.1051	0.0372	0.4016	22.7°C	117mm	45.93sec
			100.0%	11.9%	12.9%	10.0%	3.6%	38.4%	37%RH		
4	Circular		1.0484	0.1239	0.1313	0.1067	0.0346	0.3965	22.6°C	117mm	48.25sec
			100.0%	11.8%	12.5%	10.2%	3.3%	37.8%	39%RH		
5	Pear-shaped		1.0441	0.1577	0.1461	0.1078	0.0452	0.4568	22.6°C	116mm	43.88sec
			100.0%	15.1%	14.0%	10.3%	4.3%	43.8%	41%RH		
6	Triangular		1.0343	0.0563	0.1400	0.1120	0.0420	0.3503	22.6°C	120mm	43.35sec
			100.0%	5.4%	13.5%	10.8%	4.1%	33.9%	41%RH		
7	Pear-shaped	1.0326	0.1615	0.1480	0.1023	0.0374	0.4492	21.2°C	116mm	48.92sec	
		100.0%	15.6%	14.3%	9.9%	3.6%	43.5%	37%RH			
8	Circular	1.0242	0.1150	0.1101	0.1018	0.0315	0.3584	22.5°C	117mm	48.00sec	
		100.0%	11.2%	10.7%	9.9%	3.1%	35.0%	44%RH			
9	Triangular	1.0412	0.0593	0.1598	0.1256	0.0390	0.3837	23.0°C	120mm	46.90sec	
		100.0%	5.7%	15.3%	12.1%	3.7%	36.9%	43%RH			

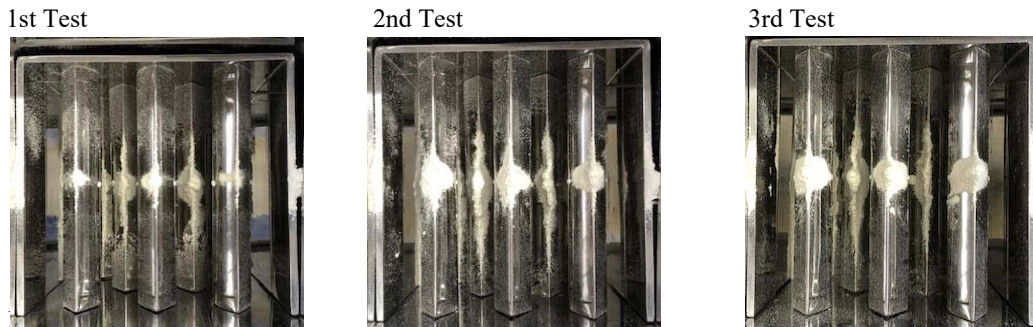

Fig. 11 Powder accumulation for pear-shaped magnet

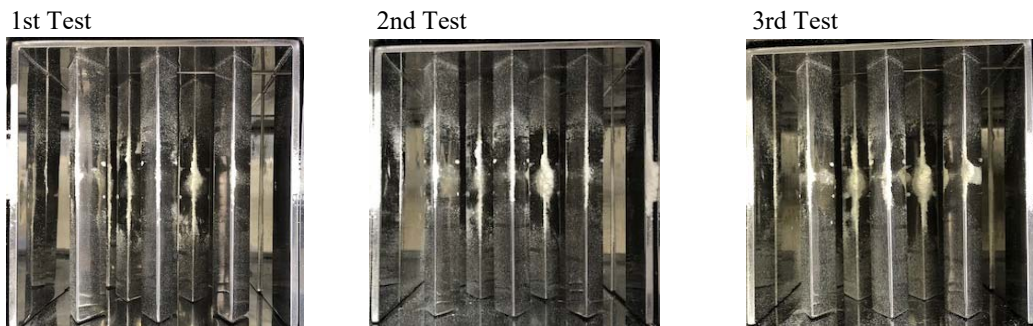

Fig. 12 Powder accumulation for triangular magnet

However, we need to consider both the magnet shape and powder flowability to effectively remove metal particles in a powder flow. The powder conditions used in this investigation involved passing the flour through an ultrasonic sieve with an aperture size of 1 mm to break lumps and then this flour was flowed through a magnetic feeder to ensure a fixed quantity and make thin for thickness of strata to attract by magnet.

The powder sample has a high accumulability; this means that pear-shaped and triangular magnets are effective as powder does not accumulate on the top of these magnets, and the magnetic fields is visible and can attract these metal particles.

The width of the three kinds of magnets is the same (25 mm), and the gap between each bar magnet at a horizontal line is the same as the width (25 mm). Thus, the magnetic separators are designed such that the metal particles in the powder are attracted to either magnet; however, the accumulated powder blocks this attraction. This means that the process of effective metal removal is essentially not accumulating powder on top of the magnet. Moreover, weakly magnetized materials can easily fall to the side by the powder flow and thus, pear-shaped or circular magnets are effective in staining the metal particles at the bottom of the magnets.

In addition, the bar magnet repel each other and are attracted to the metal particle that flows between them. The magnetic field was simulated as shown in Fig. 15, Fig. 16, and Fig. 17 for three types of magnet. Pear-shaped and circular magnets exhibited a strong attraction to each bar magnet, unlike, the triangular type.

We plotted a graph of the averaged accumulated removal rate as shown in Fig. 18. The values of the averaged accumulated removal rate are listed in Table 3; From the graph and table, it can be seen that the pear-shaped magnet is most effective for the removal of metal particles for high accumulability powder.

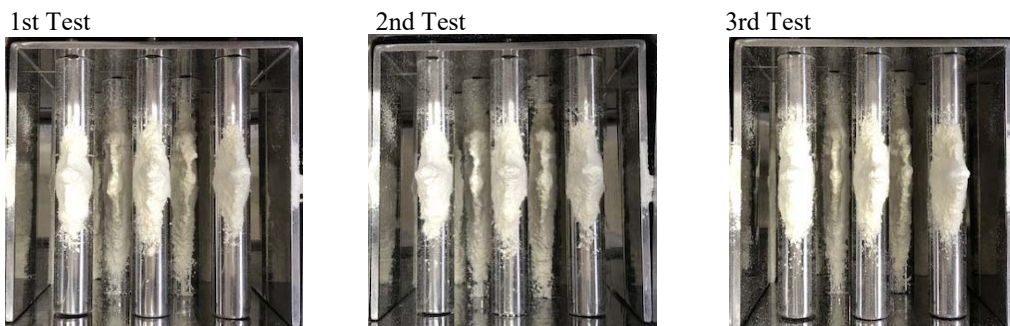

Fig. 13 Powder accumulation for circular magnet



Fig. 14 Metal particle caught by magnet

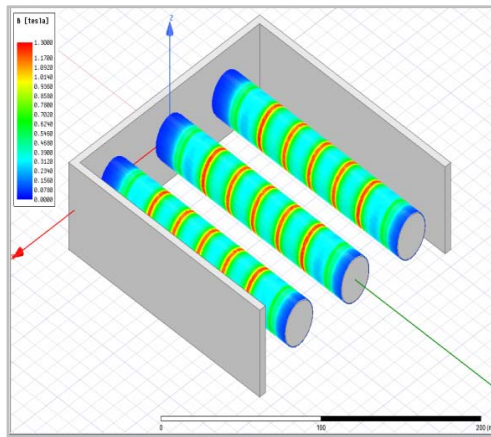

Fig. 15 Magnetic field analysis; Circular

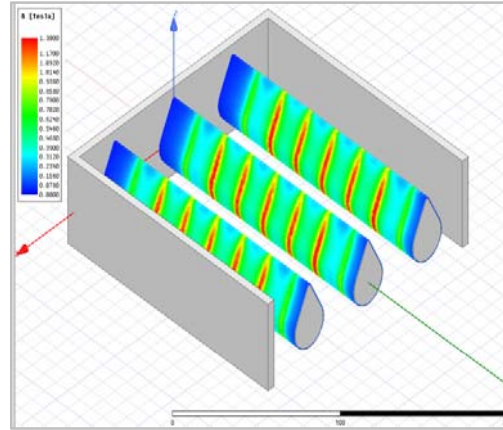

Fig. 16 Magnetic field analysis; Pear-shaped

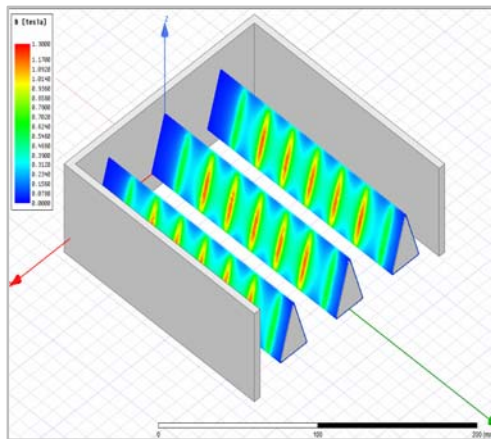

Fig. 17 Magnetic field analysis; Triangular

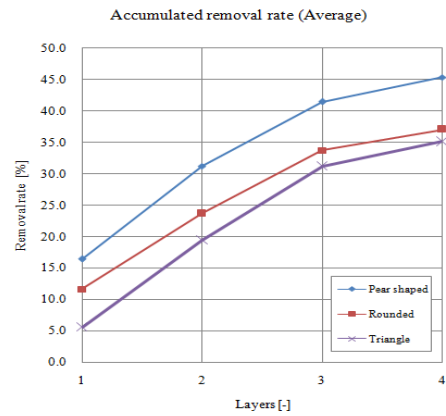

Fig. 18 Accumulated removal rate (Average)

Table 3 Accumulated removal rate (Average)

Type of magnet	Accumulated removal rate (Average) [%]			
	1st layer	2nd layer	3rd layer	4th layer
Pear-shaped	16.4	31.2	41.4	45.4
Circular	11.6	23.7	33.7	37.1
Triangular	5.6	19.4	31.2	35.1

5 Conclusions

We compared three types of magnets (circular, triangular, and pear-shaped) to remove foreign metal particles in powder for food and pharmaceutical industries. The pear-shaped type was the most effective. Owing to its shape, powder does not accumulate on the top of the pear-shaped magnet. This is also attributed to magnetic field, which continuously attracts metal particles, and prevents metal particles from staining the bottom part of the magnet. We found that difference in the effect of magnet shapes on metal contamination removal is caused by the powder does not accumulate on top of the magnets and the metal particle keep stain at the bottom of the magnets, therefore, in the future, we will conduct a study to improve the removal rate and for adherence prevention.

References

- (1) Sada, M. (2008). Reliability for Food Safety and Safety System. *The Journal of Reliability Engineering Association of Japan*, 30(6), 503-509.
- (2) Nagaoka, Y. (1967). Iron Removal from Table Salt. *Bulletin of the Society of Sea Water Science*, 21(1), 23-29.
- (3) Kennedy, W. (1957). LIQUID FILTER EMPLOYING A MAGNET. *United States Patent Office*.